

Incremental 40-mm-dia. Rotary Encoder

E6B2-CWZ6C 2000P/R 2M

Rotary Encoder, Incremental, External Diameter: 40 dia., NPN open-collector output, 2000 P/R, 5 to 24 VDC, Phases A/B/Z, Pre-wired model, 2 m

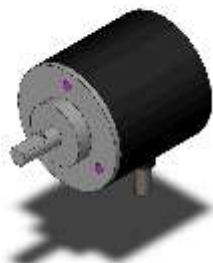

Image

Encoding method	Incremental Shaft model
Resolution	2000 P/R
Output phases	A, B and Z
Control output	NPN open collector
Connection method	Pre-wired models (Cable length: 2 m)

Ratings / Performance

As of July 25, 2024

Categorise		Incremental Shaft model
Diameter		40 mm dia.
Power supply voltage		5 to 24 VDC (-5% to +15%) Ripple (p-p) 5% max.
Current consumption		80 mA max.
Resolution		2000 P/R
Inrush current		Approx. 9 A (0.3 ms)
Output phases		A, B and Z
Control output	Output type	NPN open collector
	Load power supply voltage	30 V max.DC
	Sink current	35 mA max.
	Residual voltage	0.4 V max. (at sink current 35 mA)
Starting positional point		Equipped
Max. response frequency		100 kHz
Phase difference on output		90±45 ° between A and B (1/4 T ± 1/8 T)
Rise and fall times of output		1 µs max. (Cable length: 2 m max., output voltage: 5 V, load resistance: 1 kΩ)
Starting torque		0.98 mN.m max.
Moment of inertia		1 x 10 ⁻⁶ kg.m ² max.
Shaft loading		Radial: 30 N Thrust: 20 N
Max. permissible rotation		6000 r/min
Protective circuit		Output short-cut protection Power supply reverse polarity protection
Ambient temperature		Operating: -10 to 70 °C (with no icing) Storage: -25 to 85 °C (with no icing)

Ambient humidity	Operating: 35 to 85 % (with no condensation) Storage: 35 to 85 % (with no condensation)
Insulation resistance	Between charged parts and the case: 20 MΩ or higher (500 VDC megger)
Dielectric strength	Between charged parts and the case: 500 VAC 50/60 Hz 1 min
Vibration resistance	Destruction: 10 to 500 Hz, 2-mm or 150 m/s ² double amplitude for 11 min 3 times each in X, Y, and Z directions
Shock resistance	Destruction: 1000 m/s ² for 3 times each in X, Y, and Z directions
Degree of protection	IEC: IP50
Connection method	Pre-wired models (Cable length: 2 m)
Material	Case: ABS Main Unit: Aluminum Shaft: SUS420J2
Accessories	Instruction manual, Couplings, Hex-head spanner

As of July 25, 2024

Dimensions

As of July 25, 2024

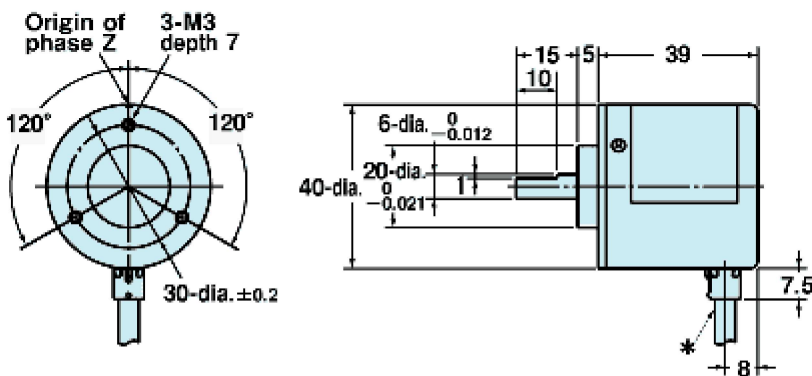

- *E6B2-CWZ6C, E6B2-CWZ5B, E6B2-CWZ3E
5-dia. Shielded cable with 5 conductors
(conductor cross section: 0.2mm², insulator diameter: 1.0mm)
Standard length: 500mm
- E6B2-CWZ1X
5-dia. Shielded cable with 8 conductors
(conductor cross section: 0.2mm², insulator diameter: 1.0mm)
Standard length: 500mm

As of July 25, 2024

Output circuit diagram

As of July 25, 2024

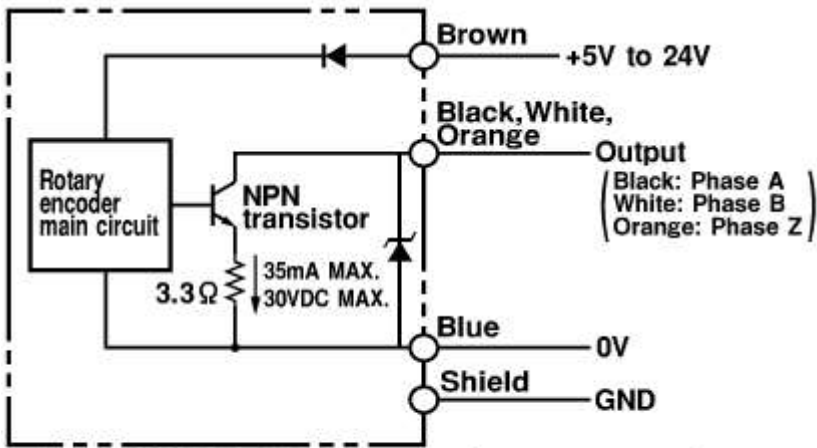

- *1. The shielded cable outer core is not connected to the inner area or the case.
- 2. Normally, connect GND to 0V or to an external ground.

As of July 25, 2024

Connected specification chart

As of July 25, 2024

Color	Terminal
Brown	Vcc
Black	Phase A
White	Phase B
Orange	Phase Z
Blue	0V(COMMON)
Shield	GND

As of July 25, 2024

Timing chart

As of July 25, 2024

Output phase	Direction of rotation	Output mode
Phase A Phase B Phase Z	CW as viewed from the end of the shaft	<p>Phase A ON/OFF</p> <p>Phase B ON/OFF</p> <p>Phase Z ON/OFF</p> <p>$T(360^\circ)$</p> <p>CW</p> <p>$1/4T \pm 1/8T(90^\circ \pm 45^\circ)$</p>
Phase A Phase B Phase Z	CCW as viewed from the end of the shaft	<p>Phase A ON/OFF</p> <p>Phase B ON/OFF</p> <p>Phase Z ON/OFF</p> <p>$T(360^\circ)$</p> <p>CCW</p> <p>$1/4T \pm 1/8T(90^\circ \pm 45^\circ)$</p>

*CW direction: Phase A is $1/4 \pm 1/8T$ faster than phase B.
 CCW direction: Phase A is $1/4 \pm 1/8T$ slower than phase B.

As of July 25, 2024