

Rugged Incremental 50-mm-dia. Rotary Encoder

E6C3-CWZ5GH 360P/R 2M

Rugged Rotary Encoder, Incremental, External Diameter: 50 dia., Complementary output, 360 P/R, 12 to 24 VDC, Phases A/B/Z, Pre-wired model, 2 m



Image

Encoding method	Incremental Shaft model
Resolution	360 P/R
Output phases	A, B and Z
Control output	Complementary output
Connection method	Pre-wired models (Cable length: 2 m)

Ratings / Performance

As of July 25, 2024

Categorise		Incremental Shaft model
Diameter		50 mm dia.
Power supply voltage		12 to 24 VDC (-10% to +15%) Ripple (p-p) 5% max.
Current consumption		100 mA max.
Resolution		360 P/R
Inrush current		Approx. 9 A (0.1 ms)
Output phases		A, B and Z
Control output	Output type	Complementary output
	Output voltage	VH: Vcc -3 V min. (IO = 30 mA) VL: 2 V max. (IO = -30 mA)
	Load current	±30 mA
Max. response frequency		125 kHz (65 kHz when using phase Z reset)
Phase difference on output		90±45 ° between A and B (1/4 T ± 1/8 T)
Rise and fall times of output		1 µs max. (Cable length: 2 m, load current: 30 mA)
Starting torque		Room temperature: 10 mN.m max. Low temperature: 30 mN.m max.
Moment of inertia		1.9 x 10 ⁻⁶ kg.m ² max.
Shaft loading		Radial: 80 N Thrust: 50 N
Max. permissible rotation		5000 r/min
Protective circuit		Output short-cut protection
Ambient temperature		Operating: -10 to 70 °C (with no icing) Storage: -25 to 85 °C (with no icing)
Ambient humidity		Operating: 35 to 85 % (with no condensation) Storage: 35 to 85 % (with no condensation)
Insulation resistance		Between charged parts and the case: 20 MΩ or higher (500 VDC megger)

Dielectric strength	Between charged parts and the case: 500 VAC 50/60 Hz 1 min
Vibration resistance	Destruction: 10 to 500 Hz, 2-mm or 150 m/s ² double amplitude for 11 min 3 times each in X, Y, and Z directions
Shock resistance	Destruction: 1000 m/s ² for 3 times each in X, Y, and Z directions
Degree of protection	IEC: IP65 Company standard: Oil resistance
Connection method	Pre-wired models (Cable length: 2 m)
Material	Case: Aluminum Main Unit: Aluminum Shaft: SUS303
Accessories	Instruction manual

As of July 25, 2024

Dimensions

As of July 25, 2024

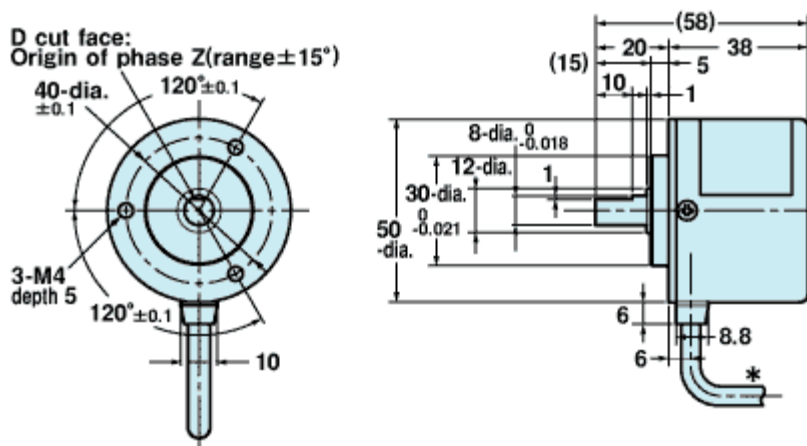

*5-dia. Oil-resistant PVC-insulated shielded cable with 5 conductors (Line driver: 8 conductors) (conductor cross section: 0.2mm², insulator diameter: 1.1mm) Standard length: 1m

As of July 25, 2024

Output circuit diagram

As of July 25, 2024

E6C3-CWZ5GH

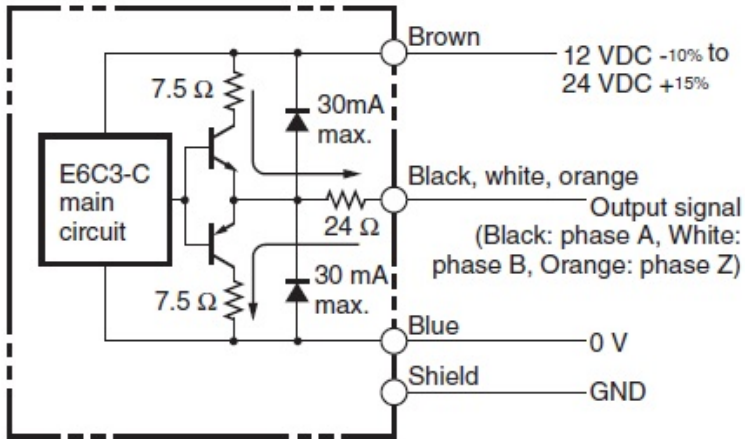

As of July 25, 2024

Connected specification chart

As of July 25, 2024

Color	Terminal
Brown	Vcc
Black	Phase A
White	Phase B
Orange	Phase Z
Blue	0V(COMMON)
Shield	GND

As of July 25, 2024

Timing chart

As of July 25, 2024

E6C3-CWZ3EH Voltage Output Model
E6C3-CWZ5GH Complementary Output Model

Direction of rotation: CW
 (as viewed from end of shaft)

Direction of rotation: CCW
 (as viewed from end of shaft)

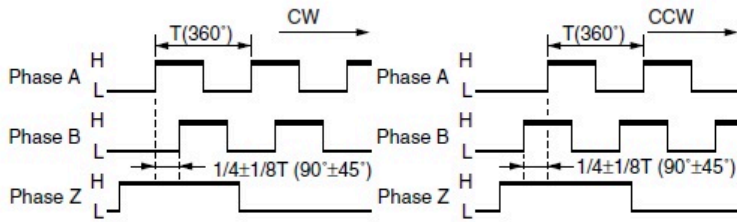

Note: Phase A is $1/4 T \pm 1/8 T$
 faster than phase B.

Note: Phase A is $1/4 T \pm 1/8 T$
 slower than phase B.

(“H” and “L” in the diagrams are the output voltage
 levels of phases A, B, and Z.)