

SICK.COM



DATA SHEET

# WTB4FP-213111A0ZZZ

W4  
Photoelectric sensors

# SICK

Sensor Intelligence

## PHOTOELECTRIC SENSORS

WTB4F-  
P-213111A0ZZZ

Illustration may differ

## ORDERING INFORMATION

Type	part no.
WTB4FP-213111A0ZZZ	1125747

Further device versions and accessories at [www.sick.com/W4](http://www.sick.com/W4)

## DETAILED TECHNICAL DATA

## FEATURES

Functional principle	Photoelectric proximity sensor	
Functional principle detail	Background suppression, MultiPulse	
Sensing range	Sensing range min.	30 mm
	Sensing range max.	100 mm
	Reference object	Object with 90% remission factor (complies with standard white according to DIN 5033)
	Minimum distance between set sensing range and background (black 6% / white 90%)	30 mm, at a distance of 100 mm
Emitted beam	Light source	PinPoint LED
	Type of light	Visible red light
	Shape of light spot	Point-shaped
	Light spot size (distance)	Ø 4.2 mm (130 mm)
	Maximum dispersion of the emitted beam around the standardized transmission axis (squint angle)	< +/- 1.5° (at T <sub>u</sub> = +23 °C)
Key LED figures	Normative reference	EN 62471:2008-09   IEC 62471:2006, modified
	LED risk group marking	Free group
	Wave length	635 nm
	Average service life	100,000 h at T <sub>a</sub> = +25 °C
Smallest detectable object (MDO) typ.	0.2 mm, At 130 mm distance (object with remission factor of 90% (complies with standard white according to DIN 5033))	
Adjustment	None	-
Display	LED green	Operating indicator

	LED yellow	Static on: power on Status of received light beam Oscillating: object present Static off: object not present
Special features		MultiPulse: sensor with self-monitoring Fixed sensing range 30 ... 100 mm Sensor for Safeguard Detector safety system

**SAFETY-RELATED PARAMETERS**

MTTF <sub>0</sub>	663 years
DC <sub>avg</sub>	0 %
T <sub>M</sub> (mission time)	20 years

**ELECTRONICS**

Supply voltage U <sub>B</sub>	10 V DC ... 30 V DC <sup>1)</sup>																		
Ripple	≤ 5 V <sub>pp</sub>																		
Usage category	DC-12 (According to EN 60947-5-2) DC-13 (According to EN 60947-5-2)																		
Current consumption	≤ 25 mA, without load. At U <sub>B</sub> = 24 V																		
Protection class	III																		
Digital output	<table border="0"> <tr> <td>Number</td> <td>1</td> </tr> <tr> <td>Type</td> <td>Push-pull: PNP/NPN</td> </tr> <tr> <td>Signal voltage PNP HIGH/LOW</td> <td>Approx. U<sub>B</sub> - 2.5 V / 0 V</td> </tr> <tr> <td>Signal voltage NPN HIGH/LOW</td> <td>Approx. U<sub>B</sub> / &lt; 2.5 V</td> </tr> <tr> <td>Output current I<sub>max</sub></td> <td>≤ 100 mA</td> </tr> <tr> <td>Circuit protection outputs</td> <td>Reverse polarity protected Overcurrent protected Short-circuit protected</td> </tr> <tr> <td>Response time</td> <td>≤ 0.5 s<sup>2)</sup></td> </tr> <tr> <td>Repeatability (response time)</td> <td>150 μs</td> </tr> <tr> <td>Switching frequency</td> <td>10 Hz<sup>3)</sup></td> </tr> </table>	Number	1	Type	Push-pull: PNP/NPN	Signal voltage PNP HIGH/LOW	Approx. U <sub>B</sub> - 2.5 V / 0 V	Signal voltage NPN HIGH/LOW	Approx. U <sub>B</sub> / < 2.5 V	Output current I <sub>max</sub>	≤ 100 mA	Circuit protection outputs	Reverse polarity protected Overcurrent protected Short-circuit protected	Response time	≤ 0.5 s <sup>2)</sup>	Repeatability (response time)	150 μs	Switching frequency	10 Hz <sup>3)</sup>
Number	1																		
Type	Push-pull: PNP/NPN																		
Signal voltage PNP HIGH/LOW	Approx. U <sub>B</sub> - 2.5 V / 0 V																		
Signal voltage NPN HIGH/LOW	Approx. U <sub>B</sub> / < 2.5 V																		
Output current I <sub>max</sub>	≤ 100 mA																		
Circuit protection outputs	Reverse polarity protected Overcurrent protected Short-circuit protected																		
Response time	≤ 0.5 s <sup>2)</sup>																		
Repeatability (response time)	150 μs																		
Switching frequency	10 Hz <sup>3)</sup>																		
Pin/Wire assignment																			
Function of pin 4/black (BK)	Digital output, object present → output Q, HIGH/LOW oscillating 10 Hz <sup>4)</sup>																		

<sup>1)</sup> Limit values.

<sup>2)</sup> Signal transit time with resistive load in switching mode.

<sup>3)</sup> With light/dark ratio 1:1.

<sup>4)</sup> This switching output must not be connected to another output.

**MECHANICS**

Housing	Rectangular						
Design detail	Flat						
Dimensions (W x H x D)	16 mm x 40.1 mm x 12.1 mm						
Connection	Connector M8, 3-pin						
Material	<table border="0"> <tr> <td>Housing</td> <td>Plastic, VISTAL®</td> </tr> <tr> <td>Front screen</td> <td>Plastic, PMMA</td> </tr> <tr> <td>Male connector</td> <td>Plastic, VISTAL®</td> </tr> </table>	Housing	Plastic, VISTAL®	Front screen	Plastic, PMMA	Male connector	Plastic, VISTAL®
Housing	Plastic, VISTAL®						
Front screen	Plastic, PMMA						
Male connector	Plastic, VISTAL®						
Weight	Approx. 30 g						
Maximum tightening torque of the fixing screws	0.4 Nm						

**AMBIENT DATA**

Enclosure rating	IP66 (EN 60529) IP67 (EN 60529)
Ambient operating temperature	-40 °C ... +60 °C
Ambient temperature, storage	-40 °C ... +75 °C
Typ. Ambient light immunity	Artificial light: ≤ 50,000 lx Sunlight: ≤ 50,000 lx
Shock resistance	30 g, 11 ms (3 positive and 3 negative shocks along X, Y, Z axes, 18 total shocks (EN60068-2-27))
Vibration resistance	10 Hz ... 1,000 Hz (Amplitude 1 mm, 3 x 30 min (EN60068-2-6))
Air humidity	35 % ... 95 %, relative humidity (no condensation)
Electromagnetic compatibility (EMC)	EN 60947-5-2
Resistance to cleaning agent	ECOLAB
UL File No.	NRKH.E181493 & NRKH7.E181493

**CERTIFICATES**

EU declaration of conformity	✓
UK declaration of conformity	✓
ACMA declaration of conformity	✓
Moroccan declaration of conformity	✓
China RoHS	✓
China Compulsory Product Certification (CCC) exempt	✓
ECOLAB certificate	✓
cULus certificate	✓
Photobiological safety (DIN EN 62471) certificate	✓

**DISPLAY AND ADJUSTMENT ELEMENTS**

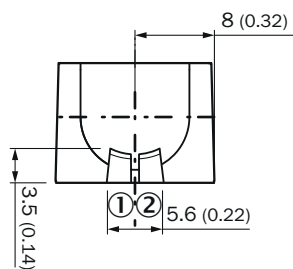

- ① LED green
- ② LED yellow

**CONNECTION TYPE CONNECTOR M8, 3-PIN**

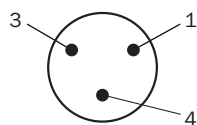

**CONNECTION DIAGRAM CD-522**

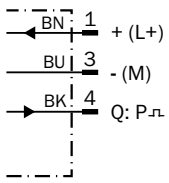

**LIGHT SPOT SIZE**

Dimensions in mm (inch)

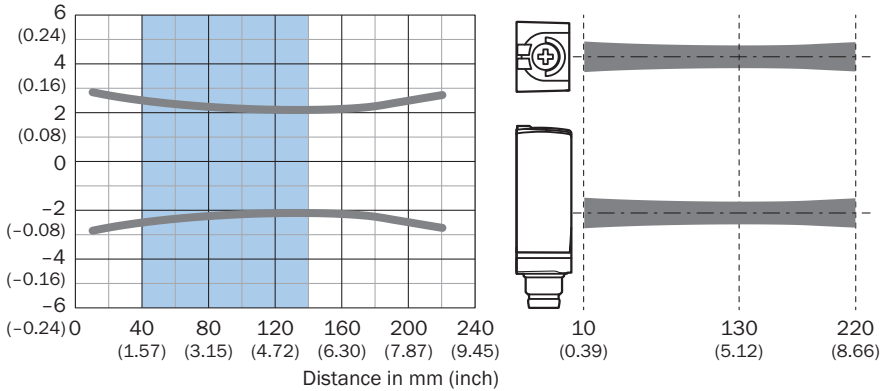

Recommended sensing range for the best performance

**FUNCTIONAL PRINCIPLE: SWITCHING STATUS**

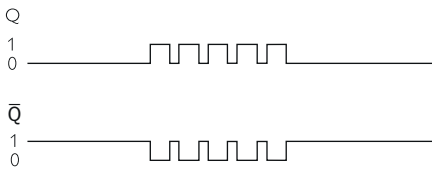
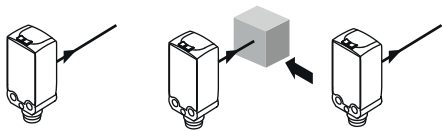

**DIMENSIONAL DRAWING**

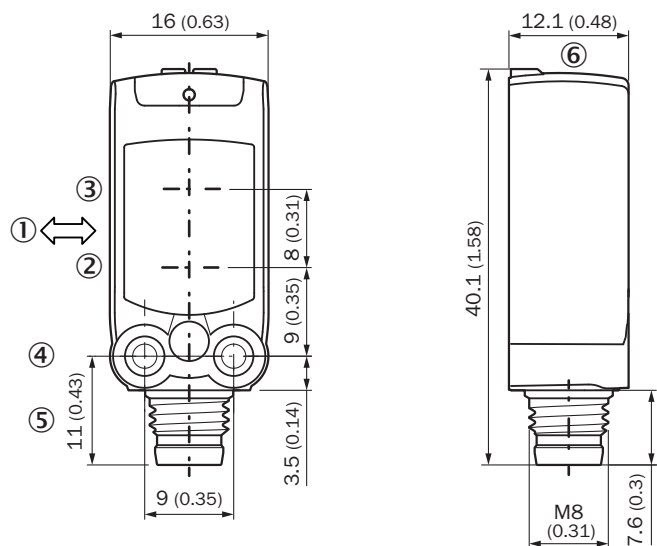

Dimensions in mm (inch)

- ① Standard direction of the material being detected
- ② Center of optical axis, sender
- ③ Center of optical axis, receiver
- ④ M3 mounting hole
- ⑤ Connection
- ⑥ display and adjustment elements

Further information as well as suitable accessories, example applications and downloads such as CAD dimensional models, operating instructions and software can be found at [www.sick.com/1125747](http://www.sick.com/1125747)



SICK AG  
WALDKIRCH  
GERMANY  
SICK.COM

# SICK AT A GLANCE

SICK is a leading global technology company for intelligent sensors and integrated solutions in industrial automation. Our technologies set benchmarks, making your industrial processes more efficient, safer and more sustainable – both in logistics and manufacturing operations.

SICK combines sensor intelligence with industry expertise and certified consulting services. We provide the ideal foundation for scalable as well as tailor-made automation solutions and create added value along the entire value chain. Our close partnerships with our customers are more than just a promise: Together, we optimize productivity, improve quality, protect health and safety, and help build a sustainable future. All with empathy and trust.

Since 1946, we have been developing innovative technologies with passion and a pioneering spirit. With a global network in around 40 countries, SICK has a global presence and is always close by. The company's headquarters are located in Waldkirch near Freiburg, Germany. Our customers benefit from our understanding of both local and global requirements, which enables us to deliver tailor-made solutions

**SICK**  
Sensor Intelligence